

Practice Paper

GRAPHIC REPRESENTATION OF DESIGNS

REGISTRO NACIONAL OF COSTA RICA

Note from the Registro Nacional:

This Practice Paper has been prepared in line with the Common Communication resulting of the Common Practice of Designs developed by the European Union Intellectual Property Network (EUIPN) and aimed to give guidance for the examination procedures on how to use the appropriate disclaimers, types of views and how to represent designs in a neutral background. Tailor-made to the specificities of Costa Rica, it provides an overview of the Registro Nacional's quality standards for design applications received by electronic means and by paper.

This Practice Paper, adopted at national level, is made public with the purpose of further increasing transparency, legal certainty, and predictability for the benefit of examiners and users alike.

1. BACKGROUND

This document will be the reference for User Associations, applicants and representatives on the practice of the requirements for graphic representation of designs.

These requirements cover the use of visual disclaimers, the use of different types of views and how to reproduce a design on a neutral background. Furthermore, this document also provides recommendations to enhance the applicants' understanding of how best to reproduce their designs and of the Registro Nacional' quality standards for design applications received by electronic means and by paper.

The following guidance relates to examination procedures only and is not intended to give advice on the scope of protection of a design under National law.

The following issues are out of the scope:

- *Verbal disclaimers*
- *Additional elements*
- *Priority*
- *Disclosure*
- *Number of views*
- *Computer-animated representations, 3D representations*

2. THE PRACTICE

The following text summarizes the key messages and the main statements of the principles of the Practice. The complete text and all the examples used to illustrate the criteria can be found in the following section of the document, including the quality standards required for applications received by electronic means and by paper.

The images should be of good quality and capable of reproduction. In order to determine the requirements of a correct graphic representation of designs, the following criteria are considered:

2.1 WITH RESPECT TO THE USE OF VISUAL DISCLAIMERS

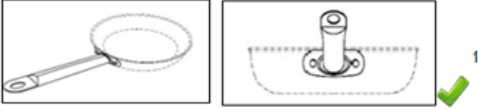
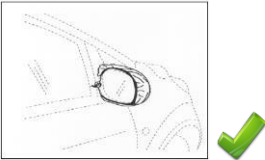
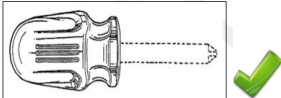
Definition	<p>Visual disclaimers indicate that protection is not being sought for, and registration has not been granted for, certain features of the design shown in the representation. Thus, they indicate what is not intended to be protected.</p>
Requirements	<p>Visual disclaimers will only be accepted when:</p> <ul style="list-style-type: none"> • They clearly indicate that protection is not being sought for certain features of the design shown in the representation. • They are shown consistently in all the views where the disclaimer appears. <div style="text-align: center;">  <p>¹ RCD No. 002322644-0001 (07.02) (pan handles) Owner: ACTERVIS, GMBH</p> </div>
Recommendations/ Guidelines	<p>Graphic or photographic representations showing only the claimed design are preferred.</p> <p>However, disclaimers can be used when the graphic or photographic representation of the design contains parts of the product for which no protection is sought. In these cases, the disclaimer must be clear and obvious: the claimed and disclaimed features must be clearly differentiated.</p> <p>Where a disclaimer is used, broken lines are recommended. Only when broken lines cannot be used due to technical reasons (for example, when they are used to indicate stitching on clothing or patterns; or photographs are used), other disclaimers can be used: colour shading, boundaries and blurring.</p>
a) Broken lines	<p>If a disclaimer is used, broken lines are recommended. They are used to indicate that no protection is sought for the features that are shown using the interrupted trace.</p> <p>In order to be accepted, the features for which protection is not sought should be clearly indicated with broken lines, whereas the parts for which protection is sought should be indicated with continuous lines.</p> <div style="display: flex; justify-content: space-around; align-items: flex-end;"> <div style="text-align: center;">  <p>BX registered design No. 38212-0001 (12.16) (Rearview mirrors) Owner: Interimage BV</p> </div> <div style="text-align: center;">  <p>Hungarian registered design No. D9900409-0001 (08.04) (handle of screwdriver) Owner: Cooper Industries, Inc.</p> </div> </div> <p>When broken lines are a feature of the design and a part of the design needs to be disclaimed, other visual disclaimers can be used.</p>

¹ For the sake of clarity, the examples marked with a «» are acceptable and the ones marked with a «» are not.

<p>b) Colour shading</p>	<p>Although broken lines are the preferred disclaimer, if they cannot be used, the use of colour shading could be an option. This type of visual disclaimer consists of using contrasting tones of colour to obscure sufficiently the features for which protection is not being sought.</p> <p>The features for which protection is sought must be clearly shown so that they are neatly perceptible, whereas the disclaimed features must be represented in a different tone of colour and in a way that they appear blurred or imperceptible.</p> <div data-bbox="810 510 1157 683" data-label="Image"> </div> <div data-bbox="751 696 1102 770" data-label="Caption"> <p>RCD No. 000910146-0004 (12.08) (Automobiles (part of-)) Owner: TOYOTA MOTOR CORPORATION</p> </div>
<p>c) Boundaries</p>	<p>Although broken lines are the preferred disclaimer, if they cannot be used, the use of boundaries could be an option. With this type of visual disclaimer, the features for which protection is sought should be clearly indicated/represented within the boundary, whereas all the features outside the boundary are considered to be disclaimed and therefore not protected. Boundaries must be carefully used in drawings/photographs due to the risk of including more than just the design within the boundary.</p> <div data-bbox="619 1099 847 1294" data-label="Image"> </div> <div data-bbox="547 1312 914 1361" data-label="Caption"> <p>RCD No. 001873688-0003 (02.04) (soles for footwear) Owner: Mjartan s.r.o.</p> </div> <div data-bbox="1034 1088 1222 1294" data-label="Image"> </div> <div data-bbox="954 1312 1321 1361" data-label="Caption"> <p>CP6 Example (12.16) (Air-intake grilles for vehicles)</p> </div>
<p>d) Blurring</p>	<p>Although broken lines are the preferred disclaimer, if they cannot be used, the use of blurring could be an option. This type of visual disclaimer consists of obscuring the features for which protection is not being sought and may only be accepted when the features for which protection is sought are clearly distinguishable from the disclaimed (blurred) features.</p> <div data-bbox="879 1637 1038 1854" data-label="Image"> </div> <div data-bbox="746 1872 1098 1946" data-label="Caption"> <p>RCD No. 000244520-0002 (12.15) (Tyres for vehicle wheels, pneumatic) Owner: Nokian Tyres plc</p> </div>

2.2 WITH RESPECT TO THE DIFFERENT TYPES OF VIEWS

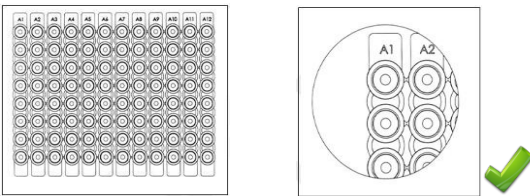
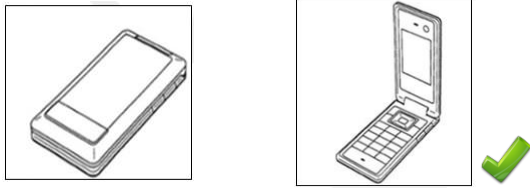
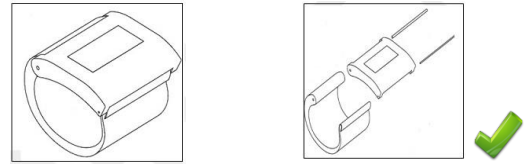

<p>Definition</p> <p>General recommendations</p>	<p>A view is a visual representation of the design. It may reproduce the design from various directions (angles) or at different moments in time or in various states.</p> <ul style="list-style-type: none"> • In most cases, aspect views (see the guidelines below) are enough for disclosing all the features of the design. However, the applicant may provide complementary/additional views in order to further disclose the features of the design (subject to the maximum number of views allowed by each Office). • It is not obligatory for the applicant to file a certain number of views or a certain type of view as long as all the features of the design can be clearly perceived, e.g. one view may be sufficient. • The views must belong to one and the same design, and each view must be shown separately. • In case of products consisting of several parts, at least one view must present the whole product.
<p>Guidelines for each type of view:</p>	<p>The use of aspect views to disclose the features of the design is preferred. However, the applicant is free to provide complementary/additional views as mentioned above.</p> <p>Therefore:</p>
<p>a) Aspect views</p>	<p>Show the design from certain directions (angles) and encompass the following views: front view, top view, bottom view, right side view, left side view, back view and perspective views. The applicant is recommended to file as many views as necessary to fully disclose the features of the design. In some cases, one view can be sufficient.</p> <div data-bbox="491 1234 1433 1413" data-label="Image"> </div> <p>RCD No. 002325456-0001 (31.00) (Mixers, electric [kitchen]) Owner: KENWOOD LIMITED</p>

<p>b) Views magnifying part of the design</p>	<p>Show one part of an overall design in an enlarged scale.</p> <p>A single magnified view is acceptable provided that the magnified part is already visible in one of the other submitted views and it is presented in a separate single view.</p> <div style="text-align: center;">  </div> <p>RCD No. 001913690-0002 (24.02) (PCR multi-well plates) Owner: ABGENE LIMITED</p>
<p>c) Alternate positions</p>	<p>Designs with alternate positions have an appearance which can be modified into several configurations without any addition or removal of any parts.</p> <p>The views showing the different configurations of the design must be shown separately.</p> <div style="text-align: center;">  </div> <p>RCD No. 000588694-0012 (14.03) (Mobile phones) Owner: Fujitsu Mobile Communications Limited</p>
<p>d) Exploded views</p>	<p>Views where the parts of a product are shown disassembled in order to clarify how the parts fit together.</p> <p>These views must be combined with at least one view representing the product assembled. All the parts of a product must be shown disassembled in a separate single view, in close proximity and in order of assembly.</p> <div style="text-align: center;">  </div> <p>Croatian registered design No. D20140080 (24.01) (Bracelets with muscle stimulator) Owner: Dominik Žinić</p> <p>Note: Showing the exploded parts in an additional view can help to facilitate the understanding of the design. However, only the parts that remain visible during the normal use of the product are protected.</p>

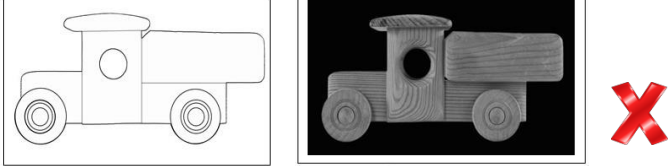
<p>e) Partial views</p>	<p>Show a part of a product in isolation.</p> <p>Partial views can be magnified and must be combined with at least one view representing the product assembled.</p> <div data-bbox="576 353 1358 495" data-label="Image"> </div> <p>RCD No. 2038216-0001 (15.01, 23.04) (Air filters, Containers for air filters, for engines) Owner: BMC S.r.l.</p>
<p>f) Sectional views</p>	<p>Cutaway portions that complement aspect views by illustrating a feature or features of the appearance of the product such as the contour, surface, shape or configuration of the product.</p> <p>Sectional views should, in an unambiguous way, be a view of the same design and must be submitted with other traditional views such as aspect views. It should be noted that representations with technical indications such as axial lines or sizes (dimensions), numbers are not allowed.</p> <div data-bbox="603 927 1273 1137" data-label="Image"> </div> <p>Modelo español registrado n.º I0152702-D (01.01) (Galletas) Titular: CUETARA, S.L.</p> <p>Note: Adding sectional views can help to facilitate the understanding of the design. However, only the parts that remain visible during the normal use of the product are protected.</p>
<p>g) Sequence of snapshots (animated designs)</p>	<p>Short sequence of views used to show a single animated design at different specific moments in time, in a clearly understandable progression. This applies to an animated icon (design consisting of a sequence) or an animated graphical user interface (design of an interface). In order to be accepted:</p> <p>The sequence of snapshots needs to be visually related (must have features in common) and it is the responsibility of the applicant to number the views in such a way so as to give a clear perception of the movement/progression.</p> <div data-bbox="520 1727 1428 1877" data-label="Image"> </div> <p>RCD No 2085894-0014 (14.04) (Animated screen displays) Owner: NIKE Innovate C.V.</p>

<p>h) Combination of several means of visual representation</p>	<p>It is recommended that a design should be represented using only one visual format (drawing, photograph) so as to avoid disclosing aspects that contribute to a different overall impression.</p> <p>Where multiple representations of a design are used, each must clearly and obviously relate to the same design and be consistent when comparing the features disclosed.</p> <div style="text-align: center;">  </div> <p style="text-align: center;">CP6 Example (21.01) (Vehicles [toys])</p>
--	---

2.3 WITH RESPECT TO NEUTRAL BACKGROUND

	<p>In order to assess if a background is neutral, the following aspects should be taken into consideration:</p>
<p>a) Requirements related to colours</p>	<ul style="list-style-type: none"> • A single or predominant colour in a background is always acceptable if it stands out against the colours of the design. • Graduating colour and more than one colour in a background is acceptable if the design is clearly distinguishable. <div style="text-align: center;">  </div> <div style="display: flex; justify-content: space-around; text-align: center;"> <div data-bbox="555 1294 805 1400"> <p>Austrian lapsed design No. 1747/1999 (01.01) (Ice lolly) Owner: Schöller Lebensmittel GMBH & O. KG</p> </div> <div data-bbox="853 1294 1104 1400"> <p>French registered design No. 955805-0005 (09.07) (Cover for perfume bottle) Owner: SNIC SARL</p> </div> <div data-bbox="1152 1294 1404 1321"> <p>CP6 Example (01.01) (Cakes)</p> </div> </div>
<p>b) Requirements related to contrast</p>	<ul style="list-style-type: none"> • All features of the design should be clearly visible. • The contrast is considered insufficient when the colour of the background and the design are similar and partly melt into each other (i.e. it is not clear where the product finishes and the background starts). • Sometimes a darker background can help when the design is clear or pale and vice-versa. <div style="text-align: center;">  </div> <div style="display: flex; justify-content: space-around; text-align: center;"> <div data-bbox="705 1892 957 1975"> <p>BX registered design No. 38895-00 (25.03) (Shed) Owner: Herman Lankwarden</p> </div> <div data-bbox="1109 1892 1369 1975"> <p>Portuguese lapsed design No. 420-0006 (06.01) (chairs) Owner: Abril Mobiliário</p> </div> </div>

c) Requirements related to shadows/ reflections

- Shadows or reflections are acceptable as long as all features of the design remain visible.
- Shadows or reflections are unacceptable when the subject of protection of the design, in any of the submitted views, cannot be determined in an unambiguous way. This can occur when there is limited colour contrast with the design, and/or shadows interfere with, or hide parts of, the design or they distort the contour of the design.



Danish registered design
No. 2013 00069 (12.11)
(wheeled cargo bike)
Owner: 3PART A/S



CP6 Example (11.02)
(Flower vases)



The Practice
Graphic Representation of
Designs

Contents

1. INTRODUCTION	1
2. THE PRACTICE.....	1
2.1 Use of visual disclaimers	2
2.1.1 Definitions.....	3
2.1.2 General requirements	4
2.1.3 General recommendations.....	5
2.1.4 Guidelines for the types of visual disclaimers.....	7
2.2 Types of views	11
2.2.1 Definition of view	12
2.2.2 Forms/means of representation	12
2.2.3 General recommendations for all types of views	12
2.2.4 Guidelines for each type of view.....	13
2.3 Neutral background	24
2.4 Format of views.....	30

1. INTRODUCTION

This document will be the reference for User Associations, applicants and representatives on the practice of the requirements for graphic representation of designs.

These requirements cover the use of visual disclaimers, the use of different types of views and how to reproduce a design on a neutral background. Furthermore, this document also provides recommendations to enhance the applicants' understanding of how best to reproduce their designs and of the Registro Nacional's quality standards for design applications received by electronic means and by paper.

The following guidance relates to examination procedures only and is not intended to give advice on the scope of protection of a design under National law.

The following issues are out of the scope:

- *Verbal disclaimers*
- *Additional elements*
- *Priority*
- *Disclosure*
- *Number of views*
- *Computer-animated representations, 3D representations*

2. THE PRACTICE

This section includes the complete text and all the examples used to illustrate the principles of the Practice. It is divided in four sub-sections:

- **Use of visual disclaimers** – addressing the use of visual disclaimers as a means to indicate features for which protection is not claimed.
- **Types of views** – addressing the types of views that can be accepted and the requirements to be established in order to represent correctly designs in an application for registration. It also determines if a combination of photographs and drawings is allowed in the representation of a design.

- **Neutral background:** defining the requirements to determine when a background is considered neutral.
- **Format of views:** developing recommendations for representations of designs filed in the form of drawings and/or photographs.

2.1 Use of visual disclaimers

Despite accepting visual disclaimers in an application for registration of a design, this practice has been defined to provide clarity to the rules/requirements concerning disclaimers, in order to assist applicants to disclose their designs correctly.

Due to the importance of appropriate disclosure of the design for the determination of the scope of protection, this section on visual disclaimers includes:

- The definition of a design and the definition of visual disclaimers.
- General requirements for the acceptability of visual disclaimers.
- General recommendations provided for all types of visual disclaimers that this document concerns.
- Guidelines for each type of visual disclaimer. These encompass:
 - A definition of each type of visual disclaimer
 - Requirements for accepting each type of visual disclaimer
 - Examples

The proposed structure can be seen in the graphic below:

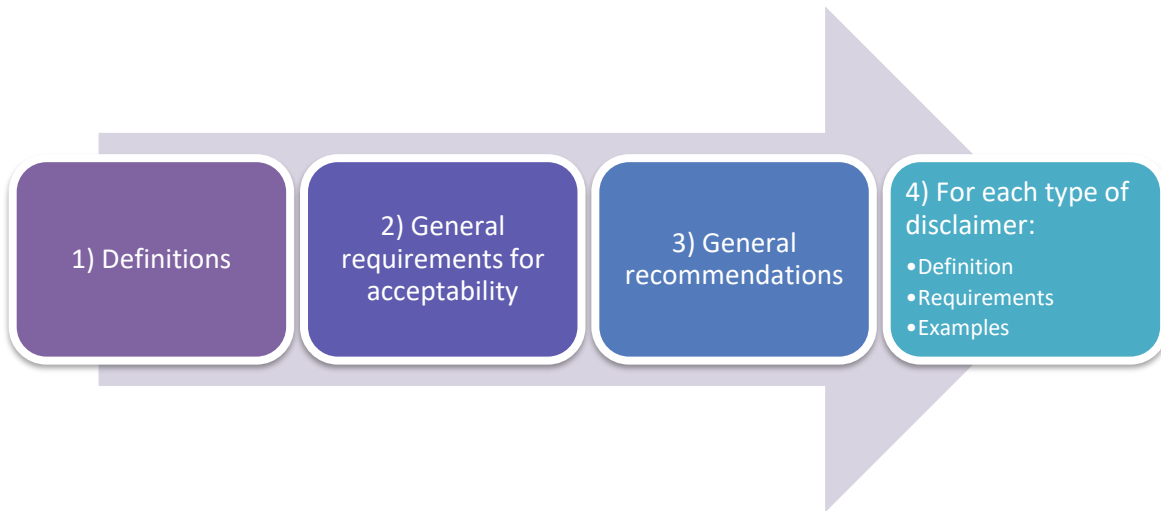

Figure 1 – Visual Disclaimers Section Structure

2.1.1 Definitions

a) Definition of a design: a “*design*” means the appearance of the whole or a part of a product resulting from the features of, in particular, the lines, contours, colours, shape, texture and/or materials of the product itself and/or its ornamentation².

b) Definition of visual disclaimers: visual disclaimers indicate that protection is not being sought for, and registration has not been granted for, certain features of the design shown in the representation. Thus, they indicate what is not intended to be protected. This can be achieved:

- By excluding with broken lines, blurring or colour shading the features of the design for which protection is not sought or
- By including within a boundary the features of the design for which protection is sought, thus making it clear that no protection is sought for what falls outside the boundary.

² ‘Graphic symbols’ and ‘typographic characters’ are protected as industrial designs, not as industrial models in Costa Rica

2.1.2 General requirements

The following are the general requirements that need to be fulfilled by all types of visual disclaimers:

- a) Visual disclaimers will only be accepted when they clearly indicate that protection is not being sought for certain features of the design shown in the representation.
- b) In order to be accepted, when the design is represented in more than one view, the visual disclaimer must be shown consistently in all the views where the disclaimer appears. For example:

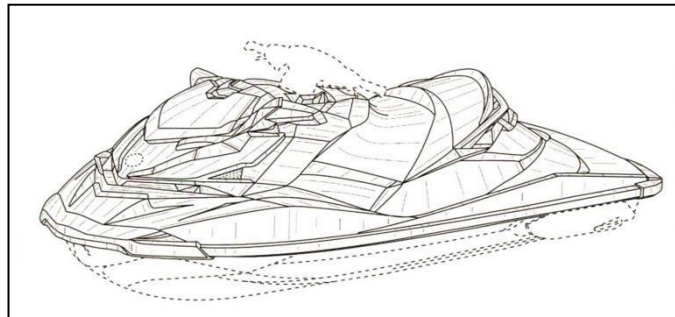
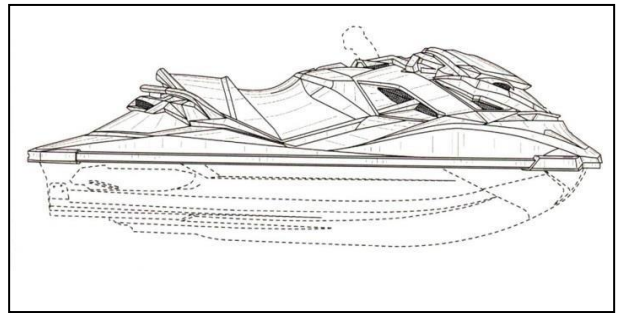
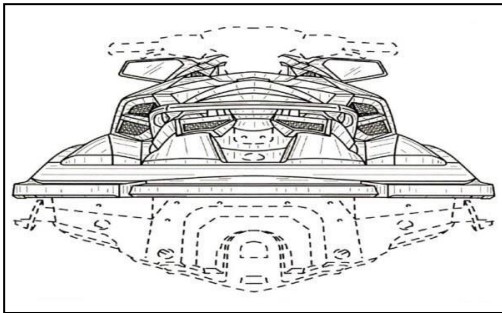

RCD No. 001282545-0001 (12.06) (Water crafts)
Owner: Bombardier Recreational Products Inc.

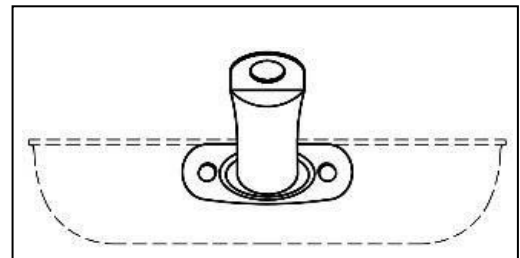
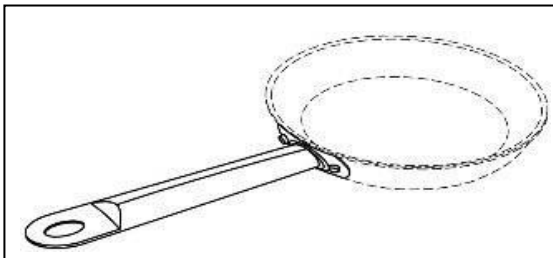

RCD No. 002322644-0001 (07.02) (Pan handles)
Owner: ACTERVIS, GMBH

Example 1 - Consistent use of visual disclaimers

2.1.3 General recommendations

The following general recommendations aim to assist applicants to correctly represent their designs using disclaimers. These recommendations are applicable to all types of disclaimers:

- a) Graphic or photographic representations showing only the claimed design are preferred.
- b) However, to understand the features of the design for which protection is sought, it may be helpful to show the design in context. In such cases the use of visual disclaimers may be necessary.
- c) Correct use:
 - The visual disclaimer must be clear and obvious from the representation of the design. There must be a clear distinction between the claimed and the disclaimed features.

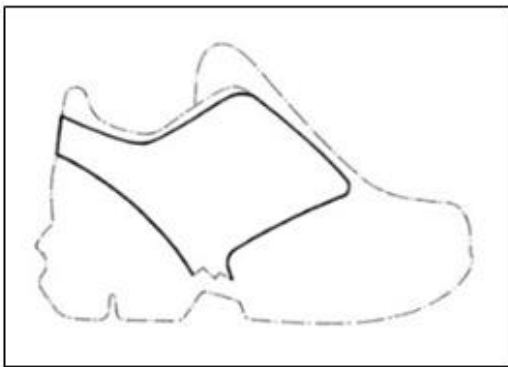

RCD No. 150297-0001 (02.04) (Footwear (part of)) Owner: Salomon SAS



International registration No. DM/078504 (12.08) (Vehicles) Owner: DAIMLER AG

Example 2 - Clear distinction between claimed and disclaimed features

- The visual disclaimer should be self-explanatory when appreciated in the context of the whole design.
- When the representations of the design are line drawings, we recommend the use of broken lines as visual disclaimers.
- However, in cases where broken lines cannot be used due to technical reasons (e.g. when the broken lines are used to indicate stitching for clothes or pattern; or photographs are used), the use of blurring, colour shading, or boundaries is recommended.

d) When to use:

It is recommended that visual disclaimers be used in those cases where the graphic or photographic representation of the design contains parts of the product for which no protection is sought.



RCD No. 002182238-0002 (26.03) (Outdoor lighting) Owner: Stanislaw Rosa trading as Zakład Produkcji Sprzętu Oświetleniowego ROSA

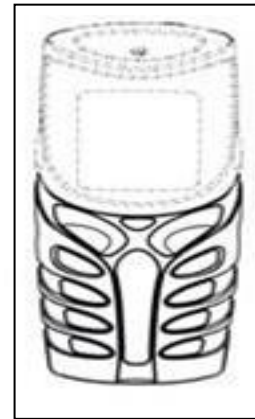

Community design lapsed No. 000030606-0003 (14.03) (Key button arrangement for mobile) Owner: Nokia Corporation

Example 3 - Useful views for showing the context

2.1.4 Guidelines for the types of visual disclaimers

a) Broken lines

Definition: Broken lines consist of a trace made up of dots or dashes (or a combination of both) and are used to indicate that no protection is sought for the features that are shown using an interrupted trace.

A visual disclaimer consisting of broken lines will usually be combined with continuous lines.

Requirements: In order to be accepted, the features for which protection is not sought should be clearly indicated with broken lines, whereas the parts for which protection is sought should be indicated with continuous lines.

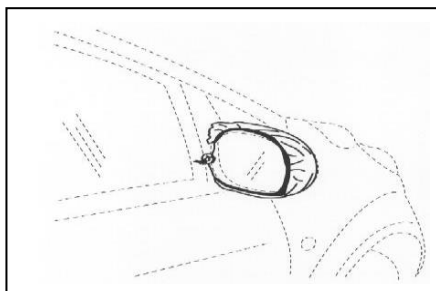

BX registered design No. 38212-0001 (12.16)
(Rearview mirrors) Owner: Interimage BV

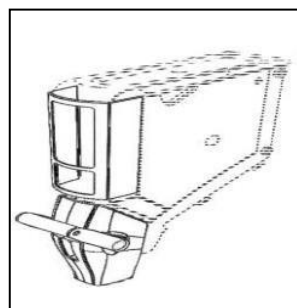

Danish registered design No. 2013 00070 (20.02)
(Parts of the device for storage, display, positioning
and distribution of varer)
Owner: Brynild Gruppen AS

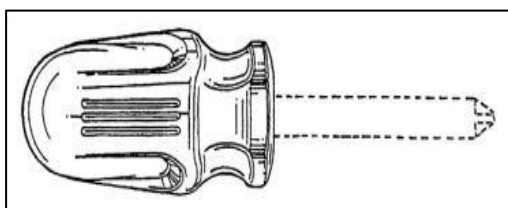

Hungarian registered design No. D9900409-0001 (08.04) (Handle of
screwdriver) Owner: Cooper Industries, Inc.

Example 4 - Broken lines

Note: In cases where broken lines are a feature of the design (such as stitching on clothing), this must be clear from the representation. In such cases, it may be helpful to file, for example, a magnified view.

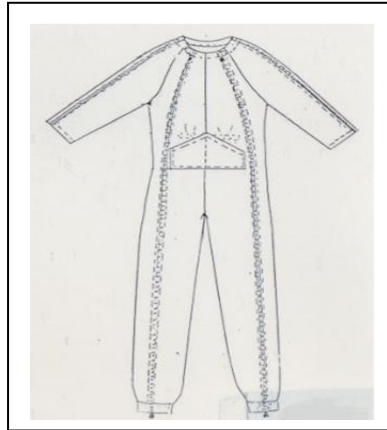

French registered design No.911104-0021 (02.02) (A pocket supporting a urine pouch) Owner: MULLIEZ FRERES SA SOCIETE INDUSTRIELLE

Example 5 - Broken lines as a feature of the design (such as stitching on clothing)

Note: In cases where broken lines are a feature of the design and a part of the design needs to be disclaimed, this can be done by using any of the other visual disclaimers, such as colour shading, blurring or boundaries.

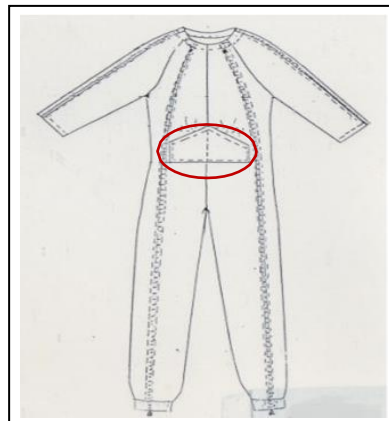

French registered design No.911104-0021 (02.02) (A pocket supporting a urine pouch) Owner: MULLIEZ FRERES SA SOCIETE INDUSTRIELLE

Example 6 - Use of other disclaimers when broken lines are a feature of the design (such as stitching on Clothing)

b) Blurring

Definition: Blurring is a type of visual disclaimer that consists of obscuring the features for which protection is not being sought in drawings or photographs of a design application.

Requirements: Blurring may only be accepted when the features for which protection is sought are clearly distinguishable from the disclaimed (blurred) features.

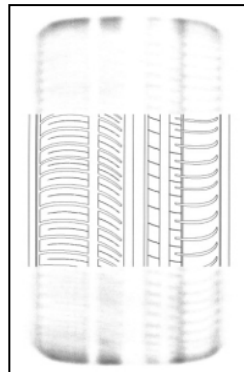

RCD No. 000244520-0002 (12.15) (Tyres for vehicle wheels, pneumatic)
Owner: Nokian Tyres plc

Example 7 - Blurring correctly applied

c) Colour shading

Definition: Colour shading is a type of visual disclaimer that consists of using contrasting tones of colour to obscure sufficiently the features for which protection is not being sought in drawings or photographs of a design application.

Requirements: With colour shading, the features for which protection is sought must be clearly shown so that they are neatly perceptible, whereas the disclaimed features must be represented in a different tone of colour and in a way that they appear blurred or imperceptible.



RCD No. 000910146-0004 (12.08) (Automobiles (part of-))
Owner: TOYOTA MOTOR CORPORATION

Example 8 - Colour shading correctly applied

d) Boundaries

Definition: Boundaries are a type of visual disclaimer used in drawings or photographs of a design application to indicate that no protection is sought for the features that are not contained within the boundary.



RCD No. 002182238-0002 (26.03) (Outdoor lighting) Owner: Stanisław Rosa trading as Zakład Produkcji Sprzętu Oświetleniowego ROSA



RCD No. 001873688-0003 (02.04) (Soles for footwear) Owner: Mjartan s.r.o.

Example 9 - Boundaries correctly applied

Requirements: In order to be accepted, the features for which protection is sought should be clearly indicated/represented within the boundary, whereas all the features outside the boundary are considered to be disclaimed and therefore not protected.

Recommendation: Boundaries must be carefully used in drawings/photographs due to the risk of including more than just the design within the boundary. For example:



CP6 Example (12.16)
(Air-intake grilles for vehicles)



CP6 Example (14.01)
(Tone arm to turntables)

Example 10 - Boundaries incorrectly applied

2.2 Types of views

The applicant should file the types of views considered appropriate for a clear, full and detailed disclosure of the design. If all the features of the design cannot be displayed in one single view, the applicant may submit additional views which are necessary for this purpose, subject to the maximum number of views allowed by each Office.

The following information aims at helping applicants to file a design application correctly with the appropriate type of view while facilitating the work of design examiners. This section on types of views contains the following:

- The definition of a view.
- A description of the possible forms/means available to applicants to represent their designs.
- General recommendations provided for all types of views that this document concerns; and
- Guidelines for each type of view. These encompass:
 - A definition of each type of view.
 - Requirements for acceptance of each type of view.
 - Recommendations for filing each type of view (if applicable).
 - Examples.

The proposed structure can be seen in the graphic below:

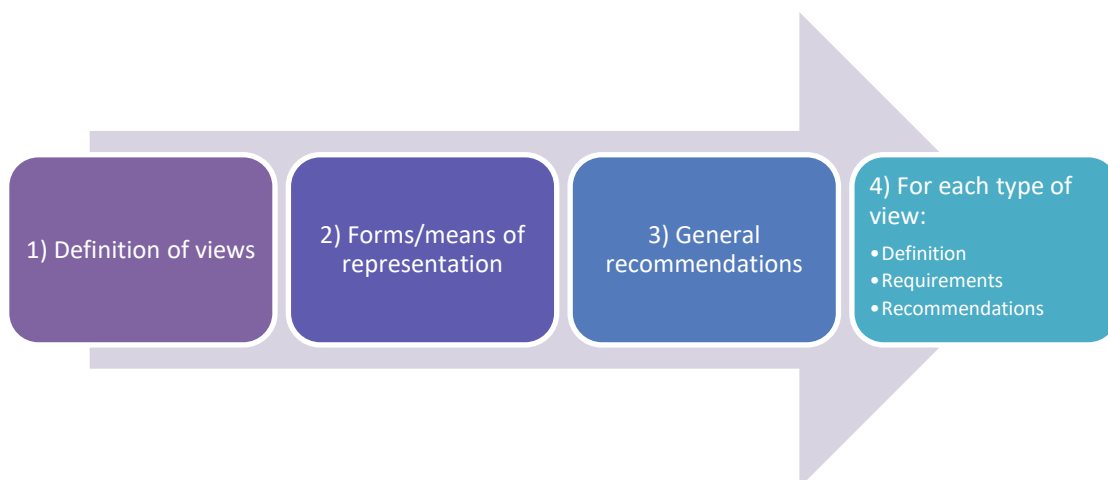

Figure 2 - Types of Views Section Structure

2.2.1 Definition of view

A view is a visual representation of the design. It may reproduce the design from various directions (angles) or at different moments in time or in various states.

2.2.2 Forms/means of representation

The representation of the design can be filed in the form of:

- a) Drawings.
- b) Photographs.
- c) Any other means of visual representation admitted by the Registro Nacional.

2.2.3 General recommendations for all types of views

The following general recommendations aim to assist applicants to correctly represent their design using types of views. These recommendations are applicable to all types of views:

- a) It is the applicant's responsibility to disclose the features of the design as completely as possible. This is most likely to be achieved by using aspect views of the design. However, the applicant may provide complementary/additional views in order to further disclose the features of the design.
- b) It is not obligatory for the applicant to file a certain number of views or a certain type of view as long as all the features of the design can be clearly perceived by the submitted representation(s), e.g. one view may be sufficient:



RCD No. 002324756-0001 (06.01) (Seating furniture) Owner: Axmann Investment GmbH



RCD No. 002327015-0001 (12.11) (Bicycle frames) Owner: Marcin, Kacper Hajek

Example 11 – Sufficient view

- c) The views must belong to one and the same design.
- d) Applicants may file one or more views of the design. Each view must be shown separately.
- e) In case of products consisting of several parts, at least one view must present the whole product.

2.2.4 Guidelines for each type of view

The project deals with the following types of views:

- a) Aspect views;
- b) Views magnifying part of the design;
- c) Alternate positions;
- d) Exploded views;
- e) Partial views;
- f) Sectional views;
- g) Sequence of snapshots;
- h) Combination of several means of visual representations.

a) Aspect views

Definition: Aspect views show the design from certain directions (angles) and encompass the following views: front view, top view, bottom view, right side view, left side view, back view and perspective views.





RCD No. 002325456-0001 (31.00) (Mixers, electric [kitchen])
Owner: KENWOOD LIMITED

Example 12 - Aspect views

Recommendations: It is recommended that the applicant should file as many views as necessary in order to fully disclose the features of the design, subject to the maximum number of views allowed by each Office. In some cases one view can be sufficient.



RCD No. 002319392-0001 (25.04) (Stools steps)
Owner: CDH GROUP (société par actions simplifiée)



RCD No. 002327015-0001 (12.11) (Bicycle frames)
Owner: Marcin, Kacper Hajek

Example 13 - Sufficient view

b) Views magnifying part of the design

Definition: Magnified views show one part of an overall design in an enlarged scale.

Requirements:

- A single magnified view is acceptable provided that the magnified part is already visible in one of the other submitted views.
- The view which shows the magnified part of the design must be presented in a separate single view.

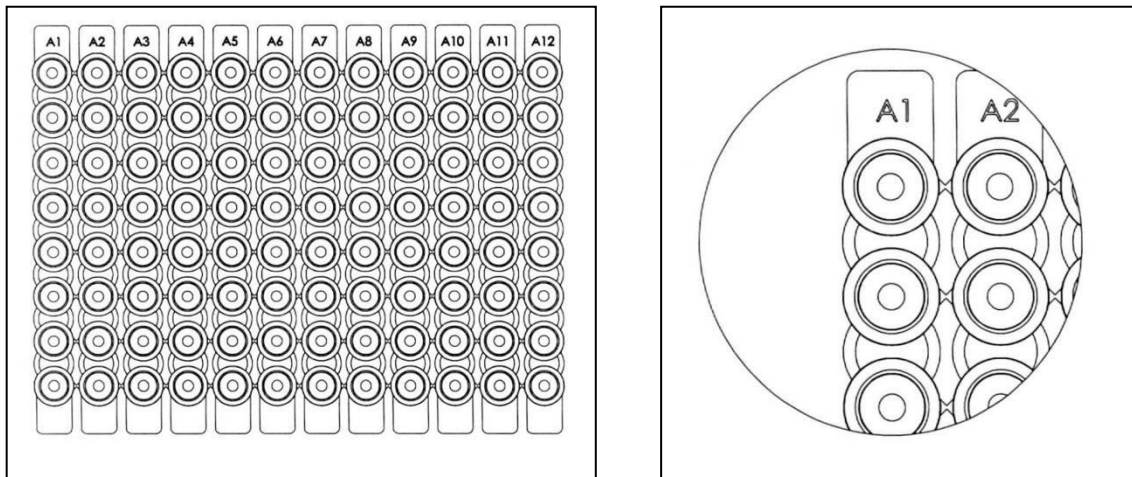

RCD No. 001913690-0002 (24.02) (PCR multi-well plates) Owner: ABGENE LIMITED

Example 14 - Acceptable (different views)

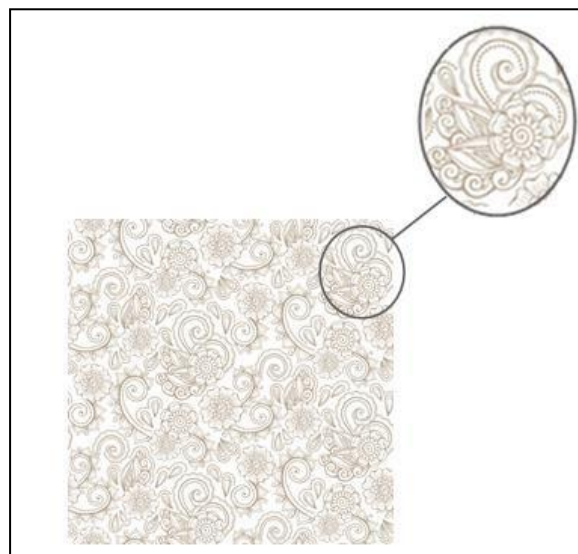

CP6 Example (32.00) (Surface patterns)

Example 15 - Unacceptable (same view)

c) Alternate positions

Definition: Designs with alternate positions have an appearance which can be modified into several configurations without any addition or removal of any parts.

These designs have pre-defined stages of use which each corresponds to an alternate position. In some cases different configurations may result in different products as in the case of a bag which is convertible into a towel (see example 16).

Requirements:

- The views showing the different configurations of the design are acceptable provided no part is added or removed.
- The views showing the different configurations of the design must be shown separately.

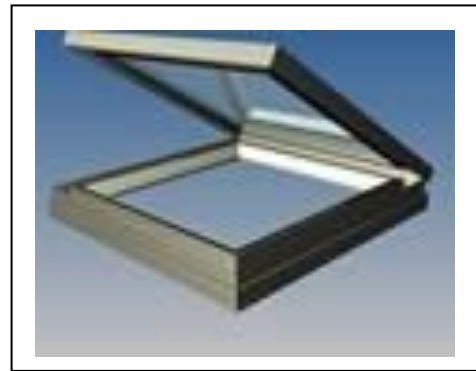
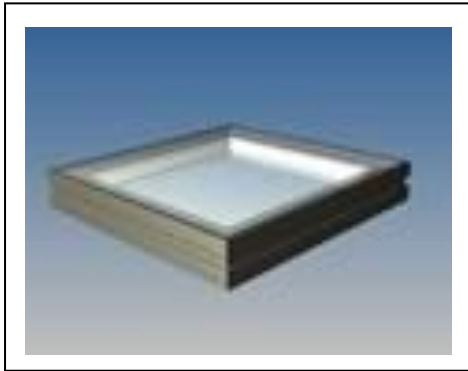

RCD No. 002257493-0001 (25.02) (Roof constructions)
Owner: Glazing Vision Ltd.

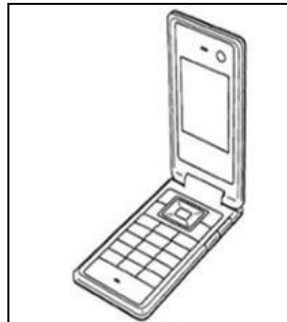

RCD No. 000588694-0012 (14.03) (Mobile phones)
Owner: Fujitsu Mobile Communications Limited



RCD No. 002319814-0001 (06.06) (Leisure furniture)
Owner: Przedsiębiorstwo Wielobranżowe KAREX Krzysztof Karpiński



RCD No. 002329938-0001 (06.01) (Chairs [seats]) Owner: Stechert Stahlrohrmöbel GmbH



RCD No. 002329938-0001 (06.01) (Chairs [seats]) Owner: Stechert Stahlrohrmöbel GmbH

Example 16 - Acceptable alternate positions (different views)

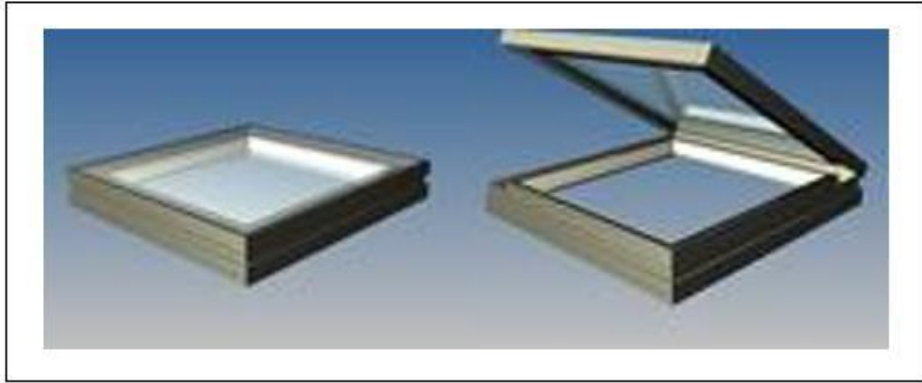

RCD No. 002257493-0001 (25.02) (Roof constructions)
Owner: Glazing Vision Ltd.

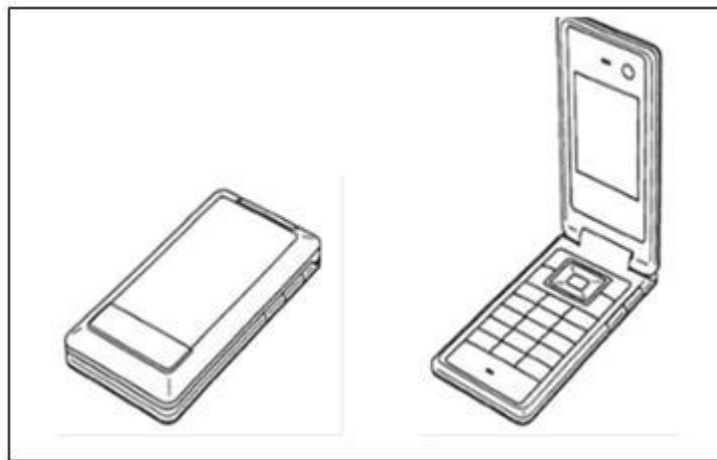

RCD No. 000588694-0012 (14.03) (Mobile phones)
Owner: Fujitsu Mobile Communications Limited

Example 17 - Unacceptable alternate positions (the pre-defined stages of use of the design are shown in the same view)

d) Exploded views

Definition: Exploded views consist of views where the parts of a product are shown disassembled in order to clarify how the parts fit together.

Requirements:

- Exploded views must be combined with at least one view representing the product assembled (see example 18 - view no.2 combined with view no.1).
- In these views, all the parts of a product must be shown disassembled in a separate single view (see example 18 - view no.2).
- The disassembled parts must be shown in close proximity and in order of assembly (see example 18 - view no.2).

View no. 1 Assembled

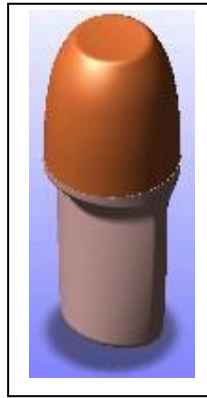

View no. 2 Exploded

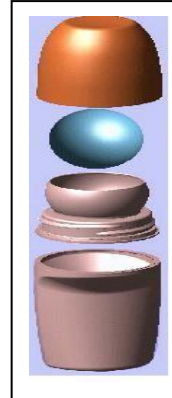

RCD No. 001847468-0003 (09.03) (Packaging)
Owner: Josefa Colls Llobet

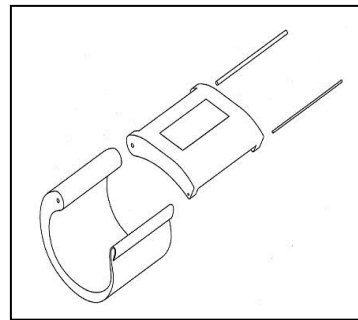
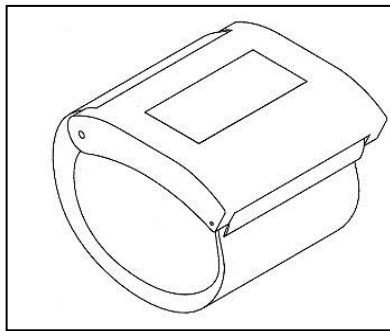

Croatian registered design No. D20140080 (24.01) (Bracelets with
muscle stimulator) Owner: Dominik Žinić

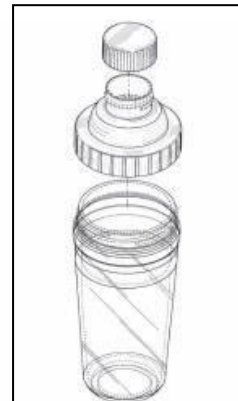
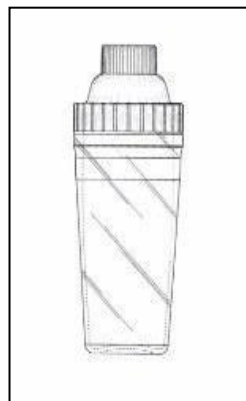

RCD 001385926-0001 (09.03) (Beverage containers)
Owner: Mocktail Beverages, Inc.

Example 18 - Exploded views

Note: Showing the exploded parts in an additional view can help to facilitate the understanding of the design. However, the suitability of using exploded views for representing the design is without prejudice to the limitations foreseen by the National or European law in respect of the protection of invisible or partially visible parts of a product when in use.

e) Partial views (fragmentary views)

Definition: A partial view is a view showing a part of a product in isolation. A partial view can be magnified.

Requirements:

- Partial views must be combined with at least one view representing the product assembled (the different parts need to be connected to each other) - see example 19, views no.2, 3 and 4 combined with view no.1.

Assembled view no. 1



Partial view no. 2



Partial view no. 3



Partial view no. 4



DMC n.° 2038216-0001 (15.01, 23.04) (Air filters, containers for air filters, for engines)
Owner: BMC S.r.l.

Example 19 - Partial views

f) Sectional views

Definition: Sectional views are cutaway portions that complement aspect views by illustrating a feature or features of the appearance of the product such as the contour, surface, shape or configuration of the product.

Requirements:

- Representations with technical indications, such as axial lines or sizes (dimensions), numbers, etc. are not acceptable.
- The sectional view should, in an unambiguous way, be a view of the same design.
- Sectional views should not be submitted without other traditional views such as aspect views.
-

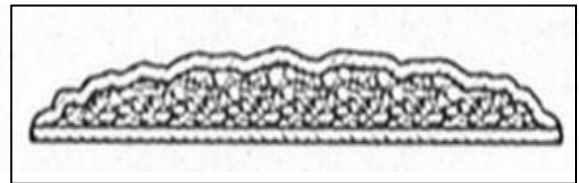
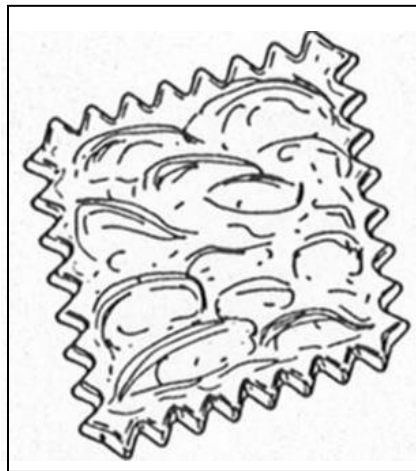

Spanish registered design No. I0152702-D (01.01) (Biscuits) Owner: CUETARA, S.L.

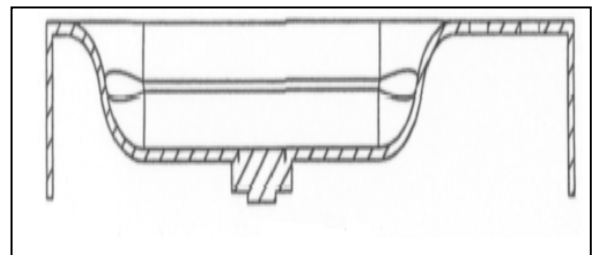
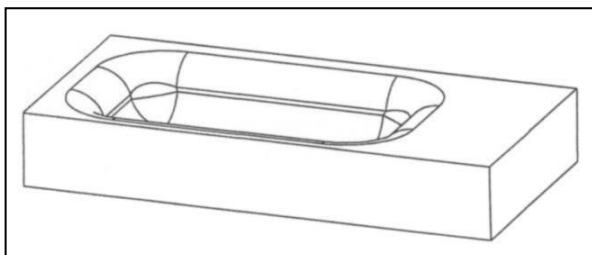

Benelux registered design No. 38478-0002 (23.02) (Sinks) Owner: Maan Amsterdam Holding BV

Example 20 - Sectional views

Note: Adding sectional views can help to facilitate the understanding of the design. However, the suitability of using such views for representing the design is without prejudice to the limitations foreseen by the National or European law in respect of the protection of invisible or partially visible parts of a product when in use.

g) Sequence of snapshots (animated design)

Definition: Snapshots are a short sequence of views used to show a single animated design at different specific moments in time, in a clearly understandable progression. This applies to:

- An animated icon (design consisting of a sequence)

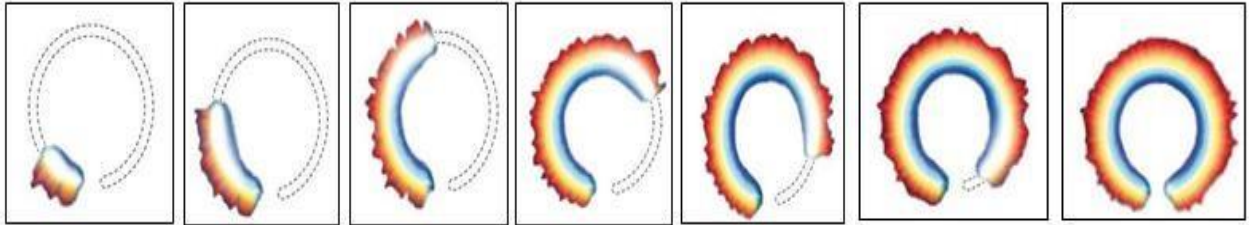

RCD No 2085894-0014 (14.04) (Animated screen displays) Owner: NIKE Innovate C.V.

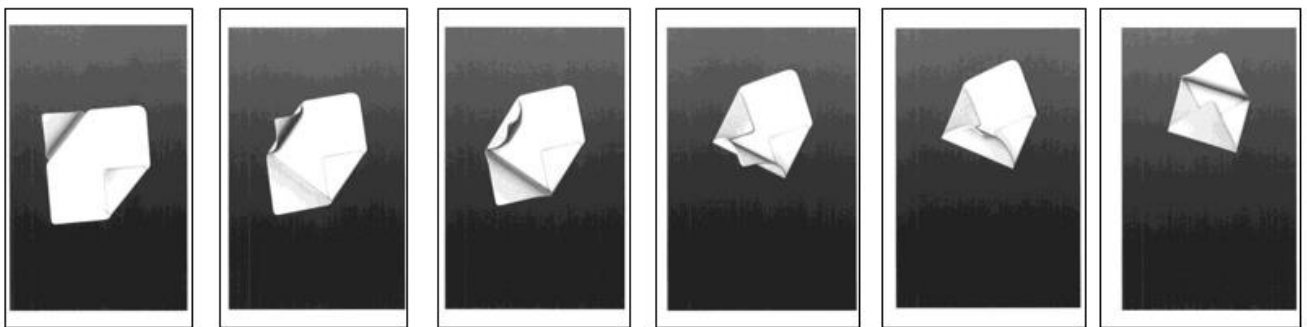

RCD No 001068001-0002 (14.04) (Icons, Animated icons, Screen displays and icons) Owner: Deutsche Telekom AG

Example 21 - Acceptable animated icons

- An animated graphical user interface (design of an interface).

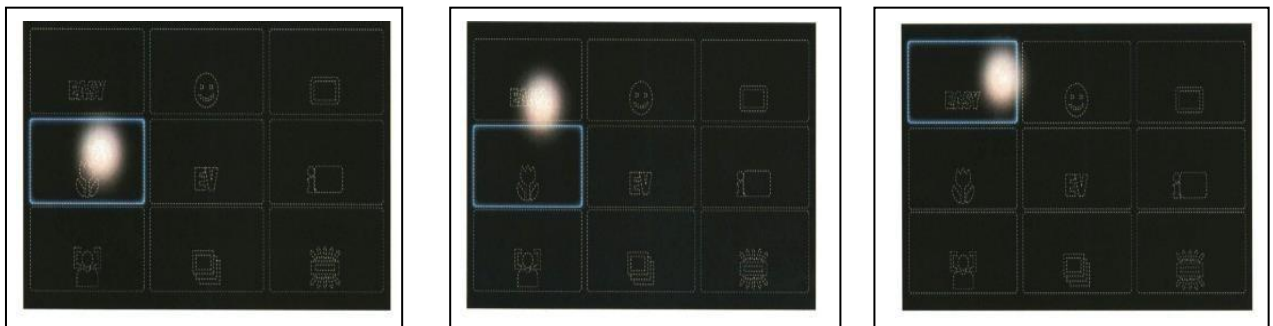

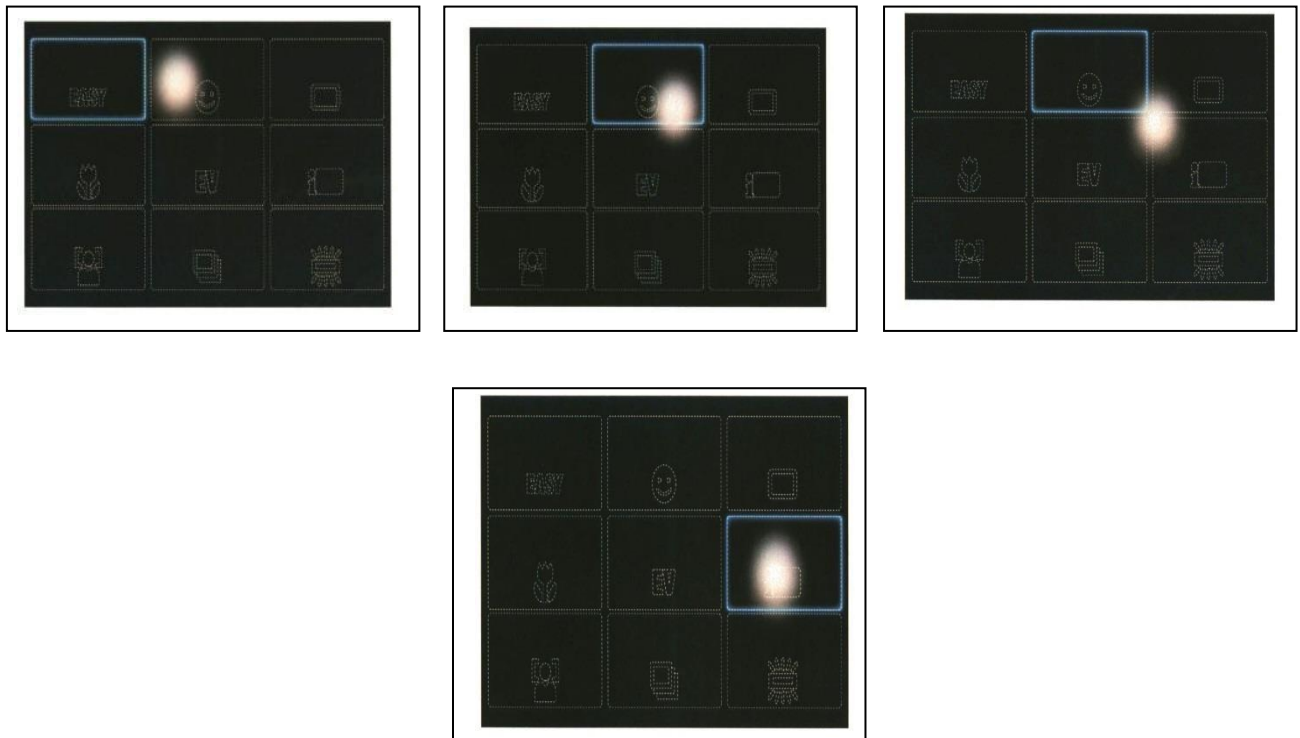

RCD No 001282388-0031 (14.04) (Animated graphical user interfaces for a display screen or portion thereof)
 Owner: Sony Corporation

Example 22 - Animated graphical user interface

Requirements:

- In principle, all views of an animated icon and graphical user interface need to be visually related, this means that they must have features in common.
- It is the responsibility of the applicant to number the views in such a way so as to give a clear perception of the movement/progression.

Note: A video clip is a potential way of representing such designs (as it allows the sequence of the movement to be seen and visually appreciated), although the technical means to file a design by submitting a video clip are not available yet.

h) Combination of several means of visual representation

Recommendation:

A design should be represented using **only one visual format** (drawing or photograph) so as to avoid disclosing aspects that contribute to a different overall impression. Where multiple representations of a design are used, each must clearly and obviously relate to the same design and be consistent when comparing the features disclosed.

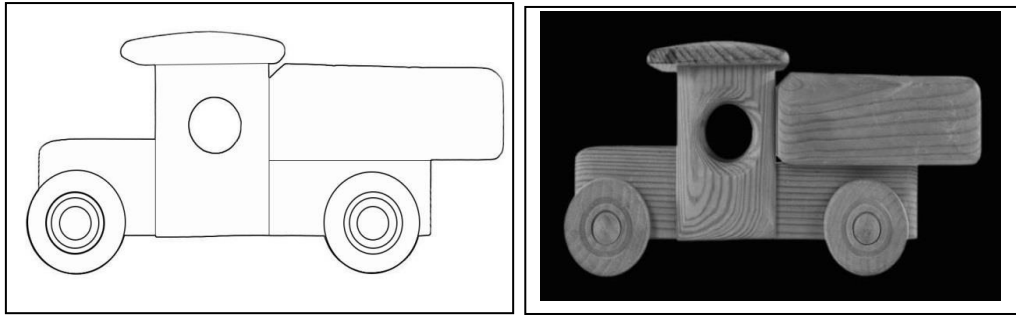

CP6 Example (21.01) (Vehicles [toys])

Example 23 - Unacceptable combination

2.3 Neutral background

Although the Registro Nacional requires design applications to be reproduced on a neutral background, there is a need for clarification of the notion of neutral background.

Therefore, in order to assess if a background is neutral, the following aspects should be taken into consideration: colours, contrast and shadows.



Figure 3 - Neutral Background section structure

2.3.1 Requirements related to coloured background

- a) A single or predominant colour in a background is always acceptable if it stands out against the colours of the design.

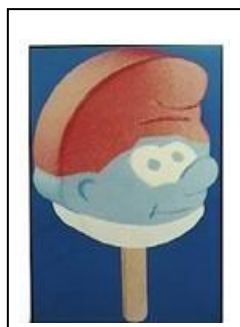

Austrian lapsed design No. 1747/1999 (01.01) (Ice lolly)
Owner: Schöller Lebensmittel GMBH & O. KG

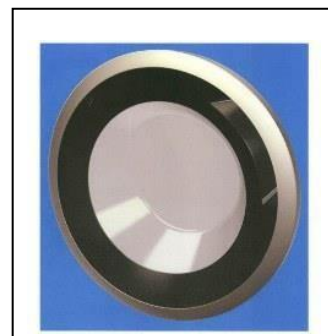

RCD No. 001390298-0001 (15.05) (Washing machines
[part of-]) Owner: BSH Hausgeräte GmbH

Example 24 - Acceptable single coloured background



CP6 Example (09.02) (Jerricans)

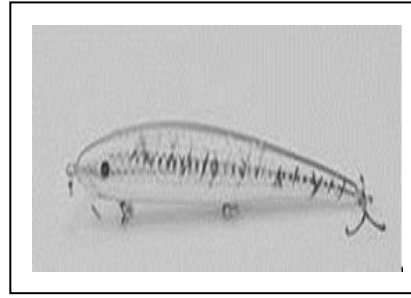

CP6 Example (22.05) (Bait for fishing)

Example 25 - Unacceptable single coloured background

b)



RCD No. 002333484-0001
(02.02) (Sportswear) Owner: La Hoya
Lorca - Club de fútbol

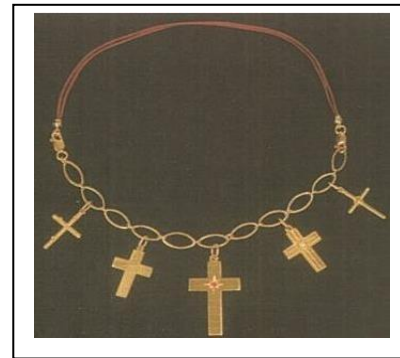

Greek lapsed design No. 20040600136-0001
(11.01) (Bracelet)
Owner: Maria Mantzagrioti Meimaridi

Example 26 - Acceptable predominant coloured background



CP6 Example (01.01) (Cakes)

Example 27 – Unacceptable predominant coloured background

b) Graduating colour and more than one colour in a background is acceptable if the design is clearly distinguishable.



Danish registered design No. 2013 00008 (23.01)
(Taps) Owner: Line Nymann, Emilie
Kampmann, Nadja Ibsen, Pernille Hinborg



RCD No. 001387476-0001 (09.01) (Bottles)
Owner: Vandemoortele Lipids, naamloze
vennootschap

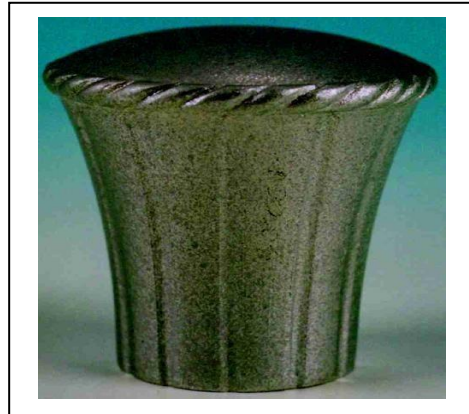

French registered design No. 955805-0005
(09.07) (Cover for perfume bottle)
Owner: SNIC SARL

Example 28 - Acceptable graduating/more than one coloured background

2.3.2 Requirements related to contrast

- a) All features of the design should be clearly visible.
- b) The contrast is considered insufficient when the colour of the background and the design are similar and partly melt into each other. The result is that not all parts of the design will have sufficient contrast with the background (i.e. it is not clear where the product finishes and the background starts).
- c) Sometimes a darker background can help when the design is clear or pale and vice-versa.



BX registered design No. 38895-00
(25.03) (Shed)
Owner: Herman Lankwarden

Example 29 – Sufficient contrast



Portuguese lapsed design No.
420-0006 (06.01) (Chairs)
Owner: Abril Mobiliário



CP6 Example (06.01)
(Chairs)



RCD lapsed design No.
000234265-0001 (09.01)
(Bottles) Owner: Torgovy Dom
Aroma (ZAO)

Example 30 – Insufficient contrast

2.3.3 Requirements related to shadows/reflections

- a) Shadows or reflections are acceptable as long as all features of the design remain visible.
- b) Shadows or reflections are unacceptable when the subject of protection of the design, in any of the submitted views, cannot be determined in an unambiguous way.

This can occur when:

- there is limited colour contrast with the design;
- shadows do not allow the appreciation of all the features of the design, for example because they interfere with, or hide parts of, the design or they distort the contour of the design.



Danish registered design No. 2013
00030 (08.05, 08.08) (Holder)
Owner: KITCINO ApS



Danish registered design No. 2013
00057 (11.01) (Jewellery)
Owner: House of Hearing



Danish registered design No. 2013
00069 (12.11) (Wheeled cargo bike)
Owner: 3PART A/S

Example 31 - Acceptable shadows



CP6 Example (11.02) (Flower vases)



CP6 Example (14.01) (Headphones)

Example 32 - Unacceptable shadows



CP6 Example (11.01) (Finger rings)

Example 33 - Acceptable reflections



CP6 Example (07.01) (Fruit bowls)



CP6 Example (07.01) (Fruit bowls)

Example 34 - Unacceptable reflections

2.4 Format of views

The quality standards required for applications received by electronic means and by paper are as follows:

Applications received by paper	
Representation of the design on paper (e.g. size of the separate sheet and other requirements)	<p>The graphic representation must be of sufficient quality, clarity and dimensions in order to appreciate all the details of the design and to allow the representation to be reproduced by photocopying and printing.</p> <p>If the graphic representations are industrial-type photographs, the object or product must be presented in a neutral background and without shadows, according to article 38 of the Regulation to the Law on Invention Patents, Industrial Designs and Utility Models.</p>
Maximum number of designs per application	Each application must contain one design or model for each class
Maximum number of views submitted per design	5 views
Number of representations that can be submitted per sheet	One (1) view per sheet
Each representation corresponds to one view?	Yes
Dimensions of the representation on photographs and drawings in a single and multiple application (minimum and maximum)	They cannot exceed 15x15 cm
Is the number of views indicated?	Yes
Are descriptions of the types of views allowed e.g. front view, back view?	Descriptions are not accepted within the presented reproduction; however, an additional sheet can be attached with a description corresponding to the perspective

Are technical drawings; explanatory text, wording or symbols allowed within the representation?	No
Number of Copies required	One set is sufficient, separate copies are not required

Applications received electronically	
Maximum number of views per Attachment	One view for each attachment
Maximum number of designs uploaded per application	Each application must contain 1 design or model for each class
Maximum number of views uploaded per design	5
File Format Type	JPEG/GIF/ PNG/BMP
Total Application Size Limit	50 mb
Size Limit per View	0.5 mb
Minimum and Maximum resolution (dpi)	No limits
Does the Registro Nacional have an E-Filing system? If so, which one? If not, is it foreseen?	WIPO FILE

2.4.1 Quality recommendations for representations of designs filed in the form of drawings and/or photographs

In order to enhance the users' understanding on how best to reproduce their designs, recommendations for representations of the designs filed in the form of drawings and/or photographs are provided below.

- a) **In the form of drawings:** The drawings should be of good quality so that the images are drawn with clear and dark continuous lines. Representations should be capable of being reproduced so that the features of the design remain clearly visible.

Thus, the following should be avoided in the representations:

- Poor line quality
- Blurry lines
- Substantial pixilation
- Lines which merge forming black and undefined areas
- Drawings which are excessively small or large
- Drawings with signs of deletion or correction.

- b) **In the form of photographs:** The representations of the design filed in the form of photographs must be of good quality. The design must be shown in such a way that all features of the displayed design are clearly visible and suitable for reproduction. In order to guarantee the quality of the photographs representations, the following should be avoided:

- Undefined areas due to a lack of lighting
- Glare on shiny, reflective or transparent surfaces
- Blurriness (unless used as a disclaimer)
- Poor contrast
- Obvious deletions or corrections.

Practice Paper